

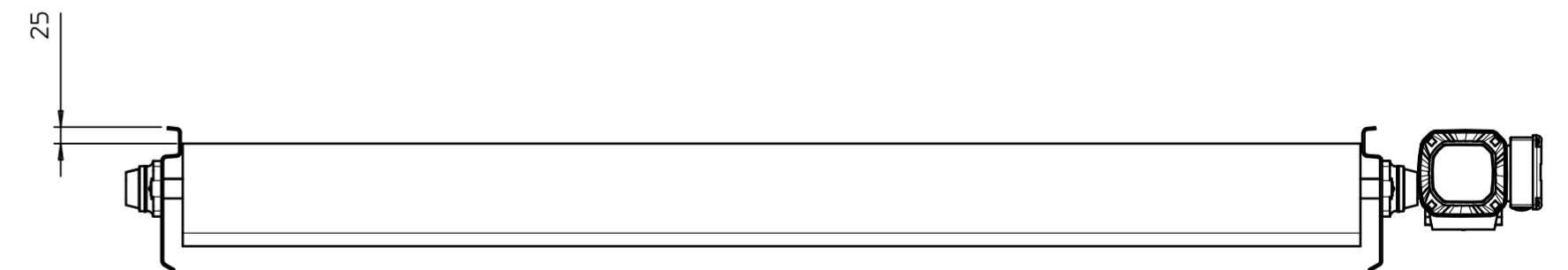

Maattoleranties tenzij anders gespecificeerd:  
 Tolerances on dimension unless specified:  
 Tot en met/ Until 2000 mm. ±0.5 mm.  
 Boven/ Above 2000 mm. ±1 mm.

Hoektoleranties tenzij anders gespecificeerd:  
 Tolerances on angles unless specified:  
 ±0.5 °

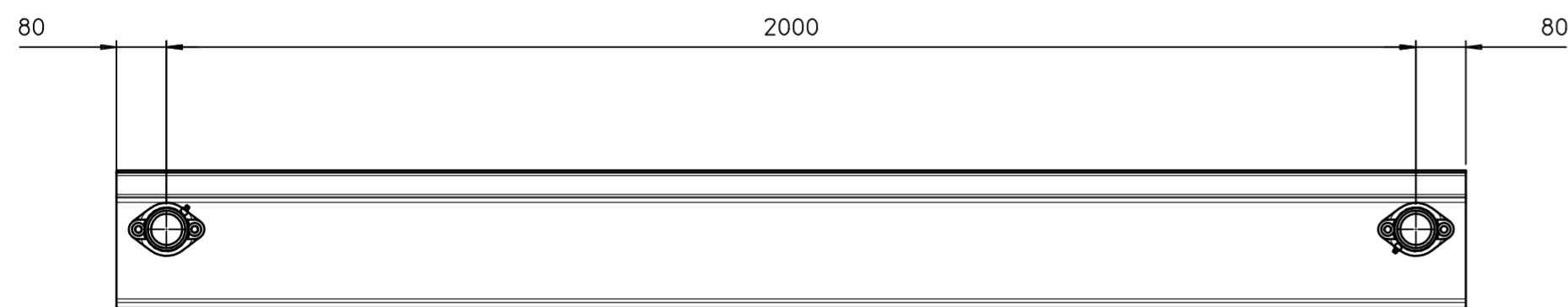
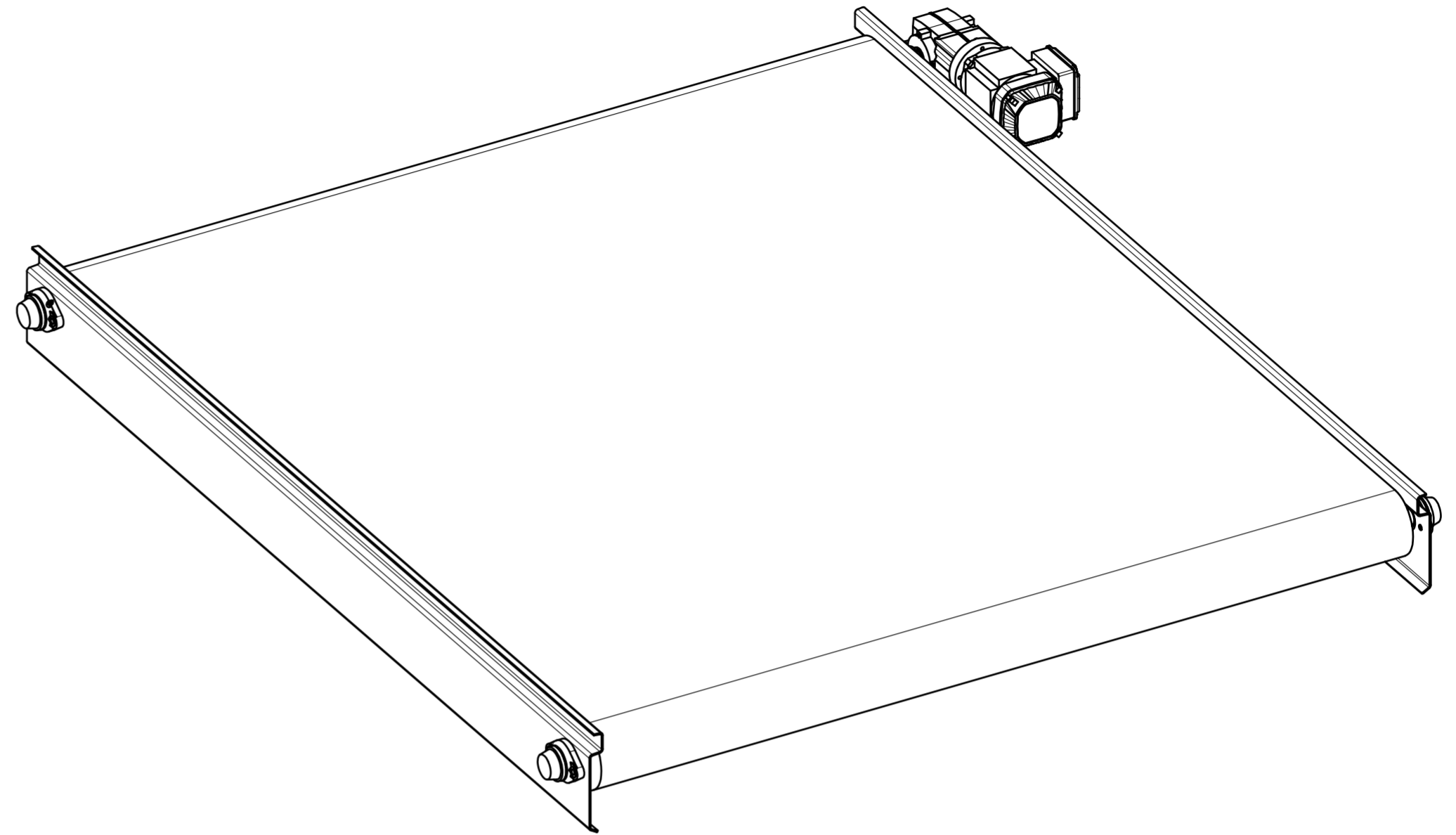
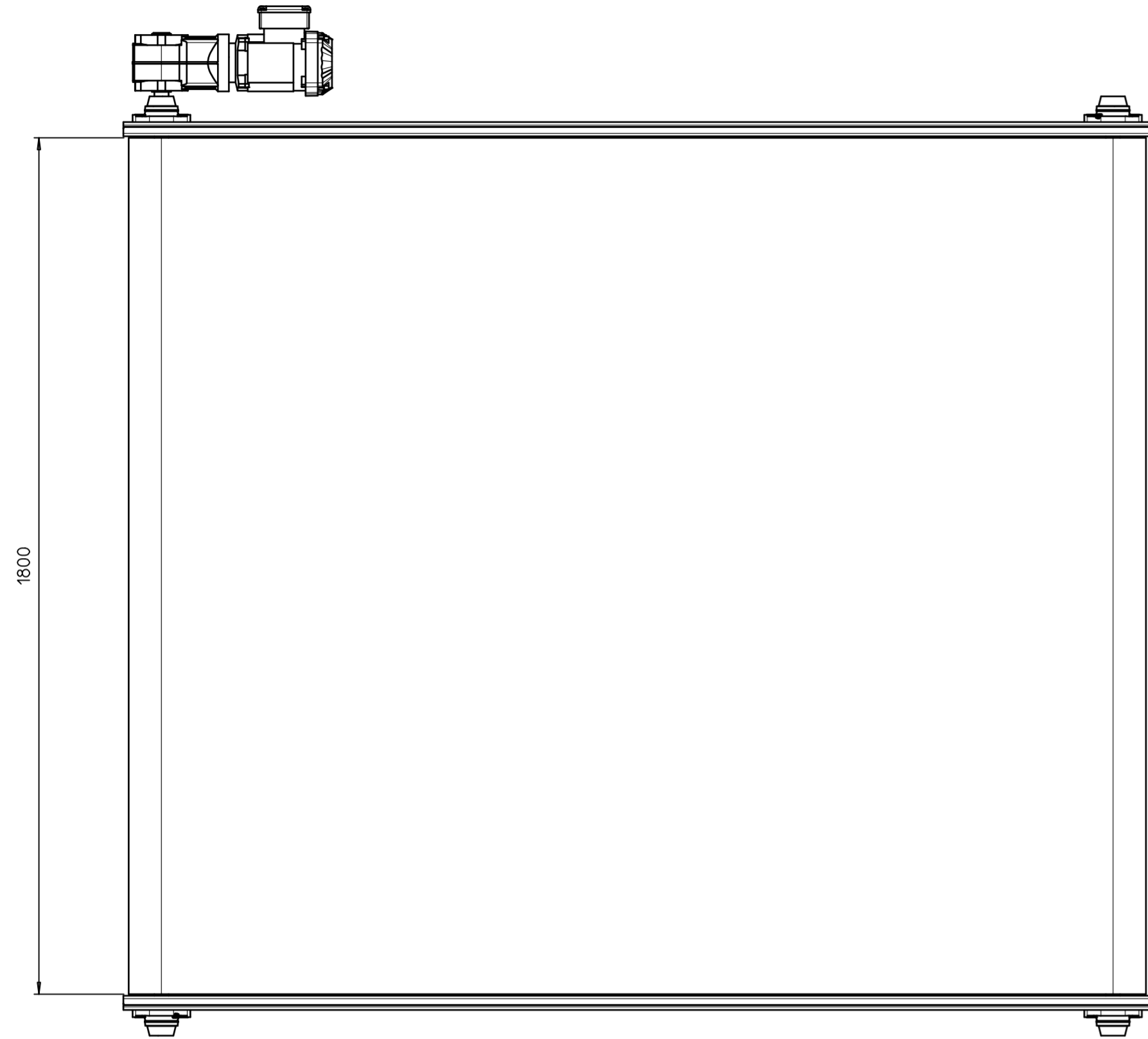
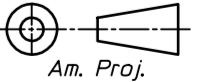

Wijz./Corr.		Datum/Date:	
 All rights are reserved. Reproduction in whole or in part is prohibited without the written consent of the copyright owner.	Schaal/Scale: 1:10	Maatv./Dimens. <i>MM</i>	 Am. Proj.
	Datum/Date: 19-06-2019	Formaat: Size: A2	
	Benaming/Name: MXST 1800 2000		MM-nr: 10599787