

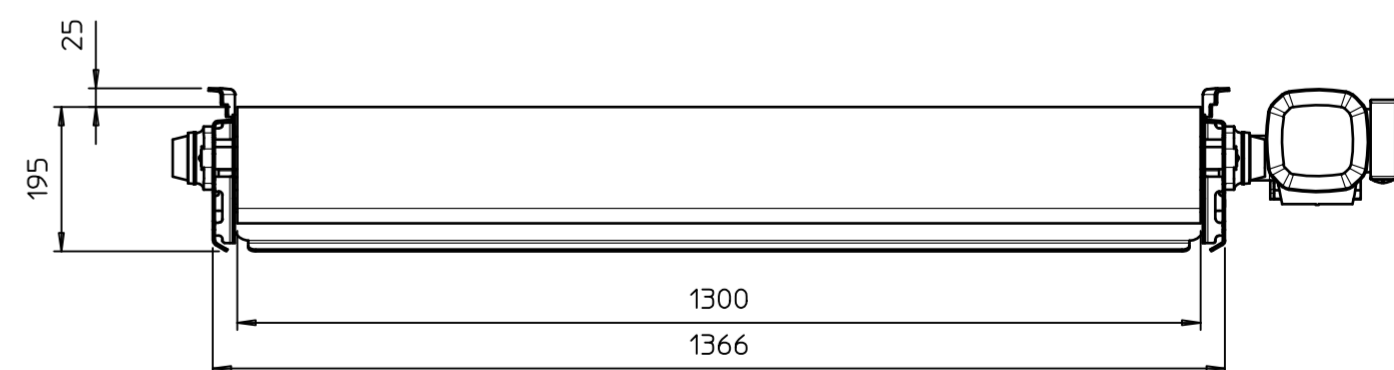

Maattoleranties tenzij anders gespecificeerd:  
 Tolerances on dimension unless specified:  
 Tot en met/ Until 2000 mm. ±0.5 mm.  
 Boven/ Above 2000 mm. ±1 mm.

Hoektoleranties tenzij anders gespecificeerd:  
 Tolerances on angles unless specified:  
 ±0.5 °

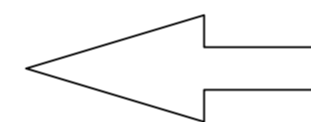
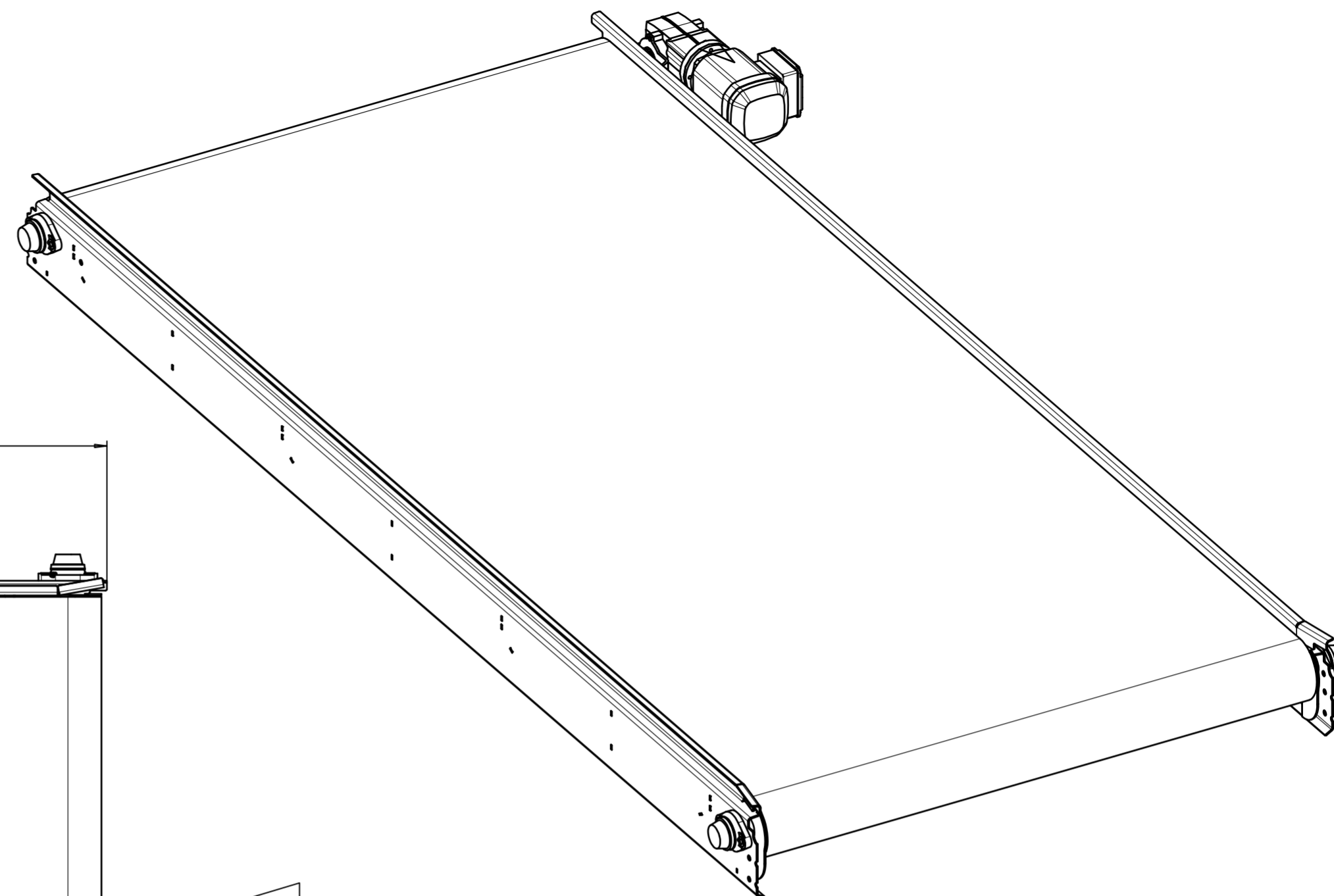
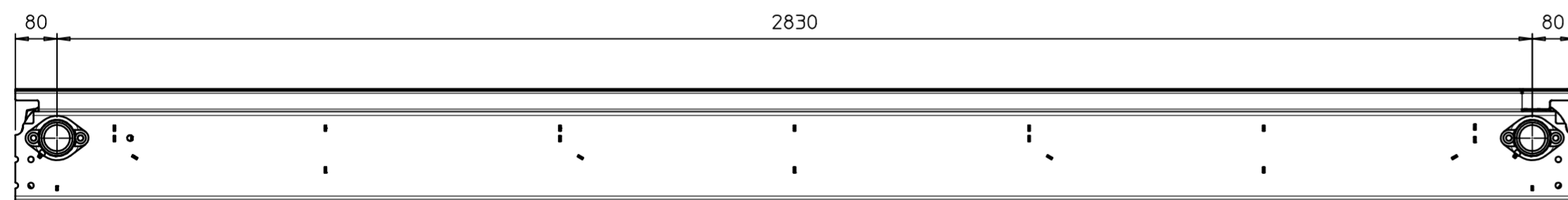
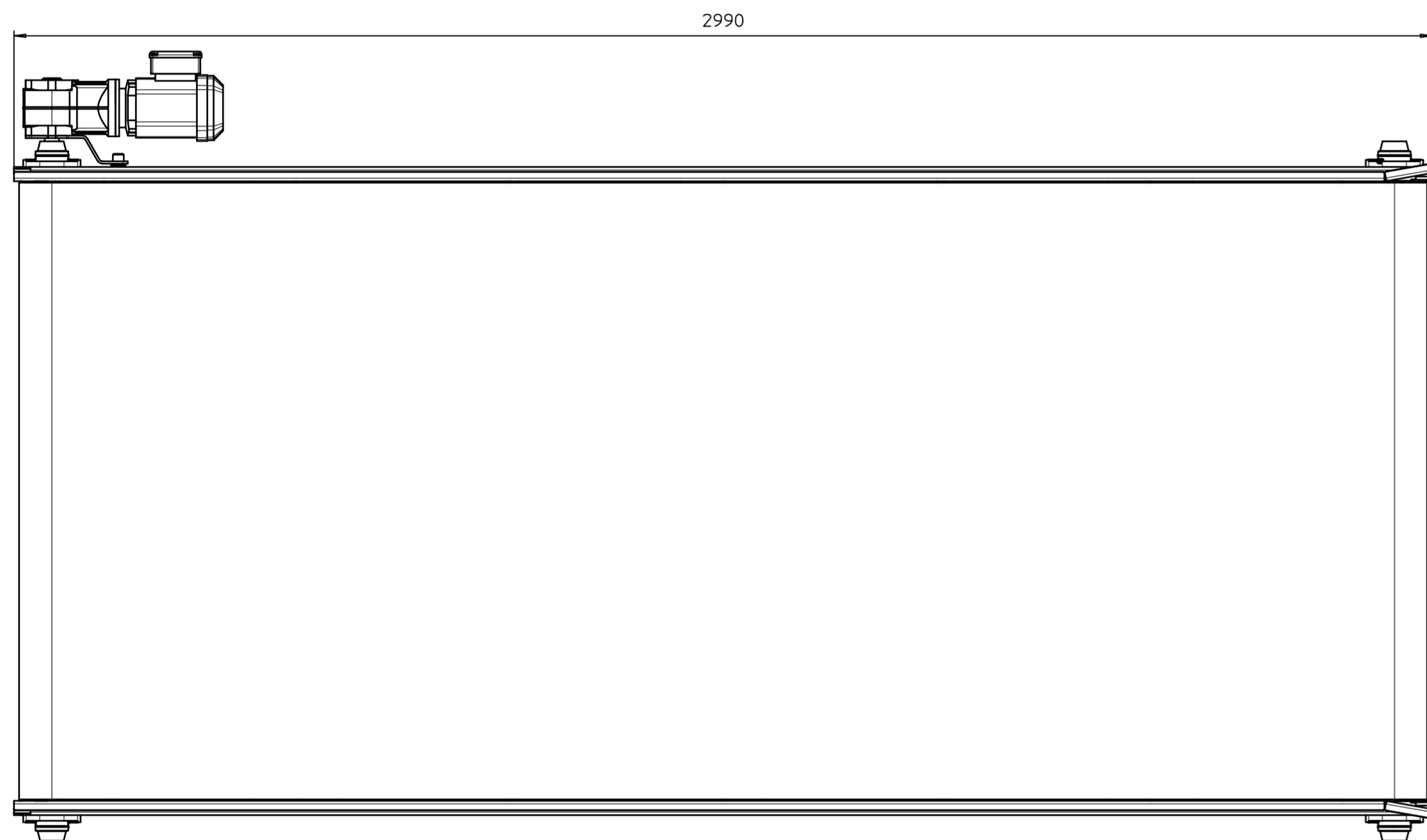
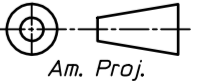

Versie/ Version		Datum/Date:	
Wijz./Corr.		Maatv./Dimens. <i>MM</i>	
 All rights are reserved. Reproduction in whole or in part is prohibited without the written consent of the copyright owner.	Schaal/Scale: 1:10	 Am. Proj.	
	Datum/Date:		Formaat: Size:
Get./Drawn:		Benaming/Name:	MM-nr: <input type="checkbox"/> Versie: Version: <input type="checkbox"/>