

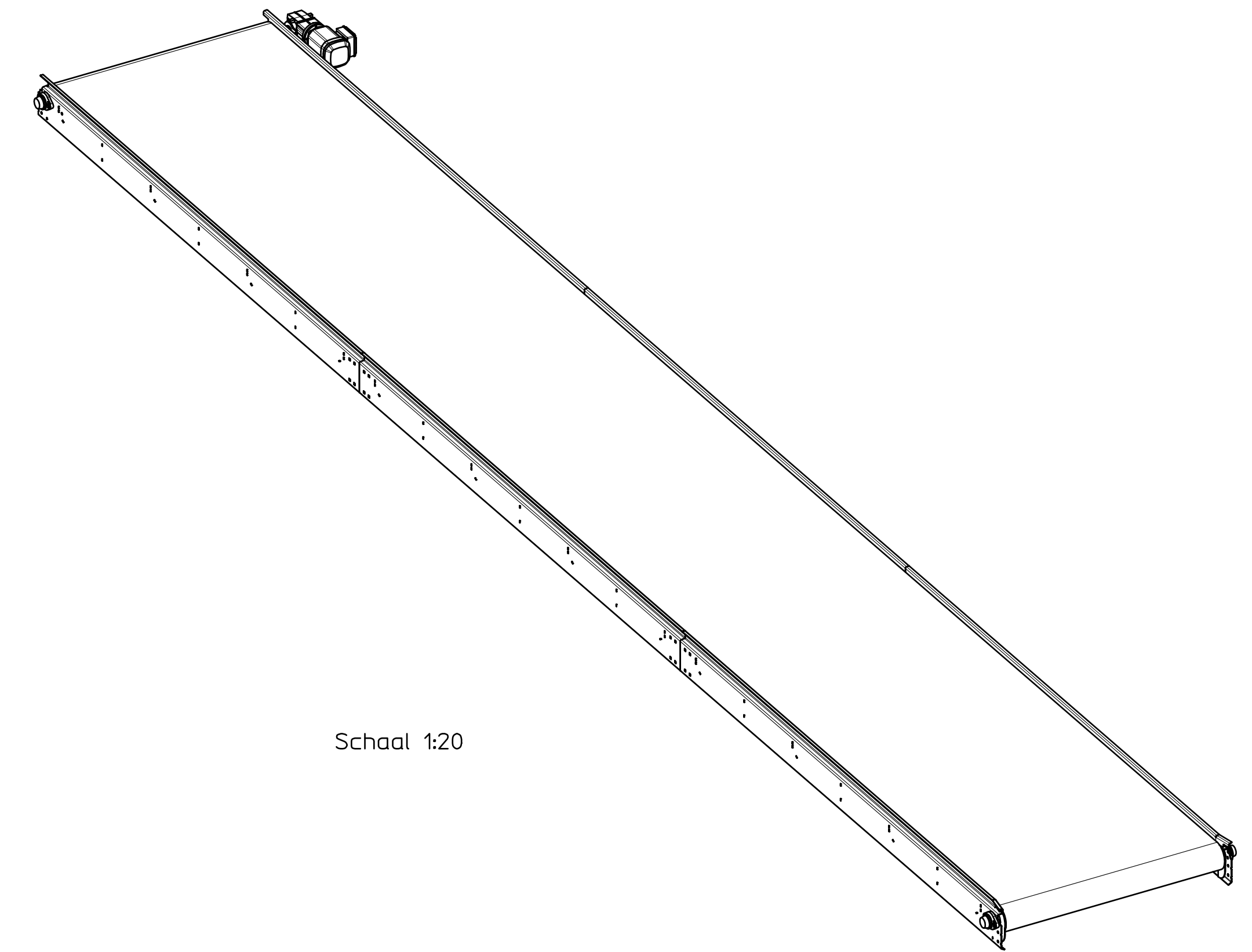

Maattoleranties tenzij anders gespecificeerd  
Tolerances on dimension unless specified  
Tot en met/ Until 2000 mm ±0.5 mm.  
Boven/ Above 2000 mm ±1 mm.

Hoektoleranties tenzij anders gespecificeerd  
Tolerances on angles unless specified  
±0.5 °

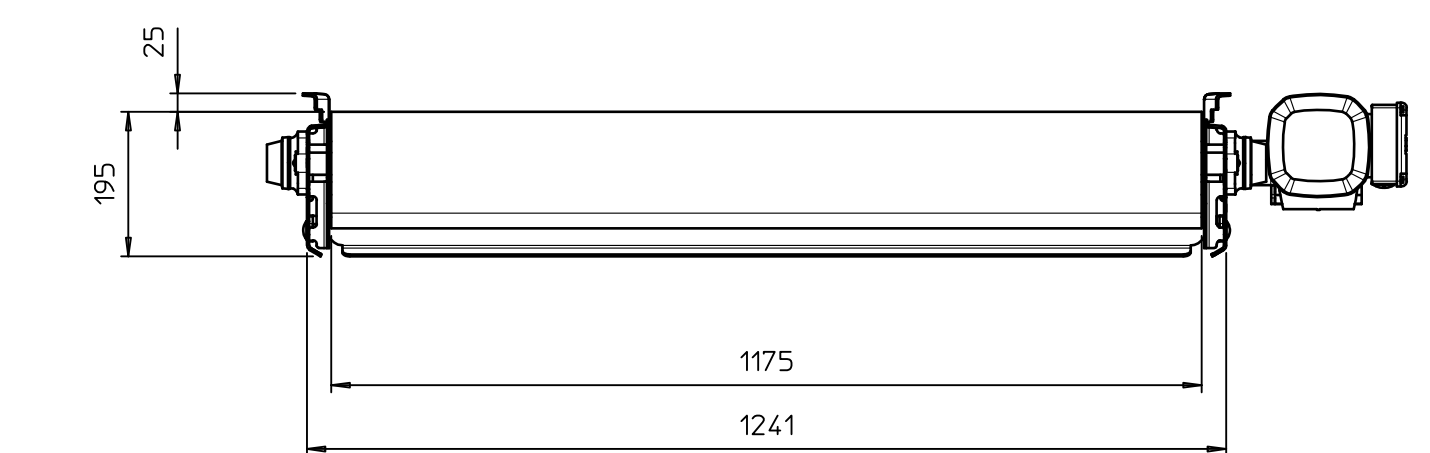
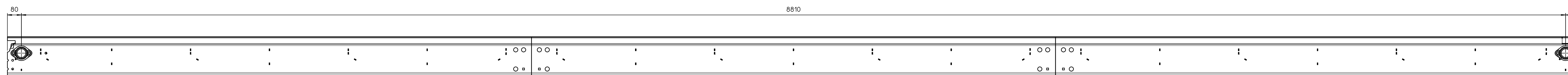
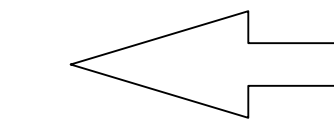
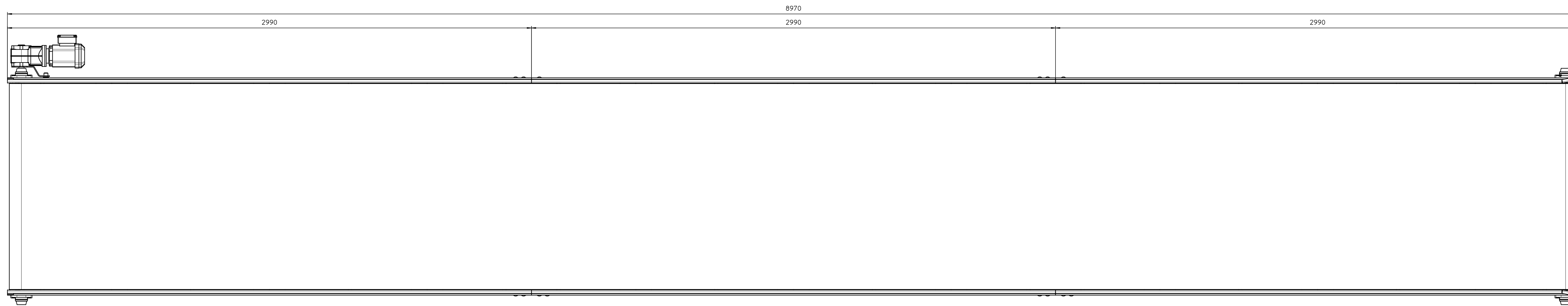

Schaal 1:20

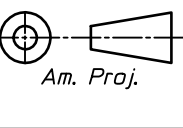

Mijz./Corr.		Datum/Date:			
 All rights are reserved. Reproduction in whole or in part is prohibited without the written consent of the copyright owner.	Schaal/Scale: 1:10	Maatv./Dimens. <i>MM</i>		 AS PRO	Versie: <input type="checkbox"/> 105-rv1
	Datum/Date:	Formaat/Size:			
	Get./Drawn:	Benoeming/Name:			